

Electrolux

REFRIGERATOR/FREEZER TR1168D



User's Handbook

Your new Electrolux fridge/freezer has two separate compartments. The automatically defrosted fridge compartment is at the top and the freezer is at the bottom. The freezer will store frozen food and freeze quantities of fresh food.

For best results, it's important that you read all the contents of this handbook before you use your fridge/freezer.

At first you may be aware of sounds in your kitchen which you are not used to, particularly if your fridge/freezer is against sound-reflective surfaces such as tiled or painted walls. Please remember the cooling unit includes precision-built components which, like those in car engines and other machinery with fast moving parts, need a running-in period which may last for several weeks. During this period, don't worry, — just allow the appliance time to settle down.

Before using your fridge/freezer, we advise you to wash the inside and fittings as described on page 14 under 'cleaning.'

Note: To support the freezer door during transit, a plastic packing piece is wedged between the door and lower hinge. The packing piece should be removed, after opening the door, and kept for re-use should you move house at a future date.

- 1 Interior light switch (refrigerator)
- 2 Thermostat knob (refrigerator)
- 3 Cooling plate
- 4 Drink cooler
- 5 Wet tray
- 6 Defrost water drain (refrigerator)
- 7 Door shelf
- 8 Salad drawers
- 9 Bottle gripper
- 10 Ice store
- 11 Freezing/storage shelf
- 12 Interior light switch and warning lights (freezer)
- 13 Thermostat knob and switches (freezer)
- 14 Storage baskets
- 15 Defrost flip spout (freezer)
- 16 Level adjusters

SAFETY NOTE

If this appliance is replacing an old one which is going to be scrapped, please remove the door before disposal to prevent children from becoming trapped inside.

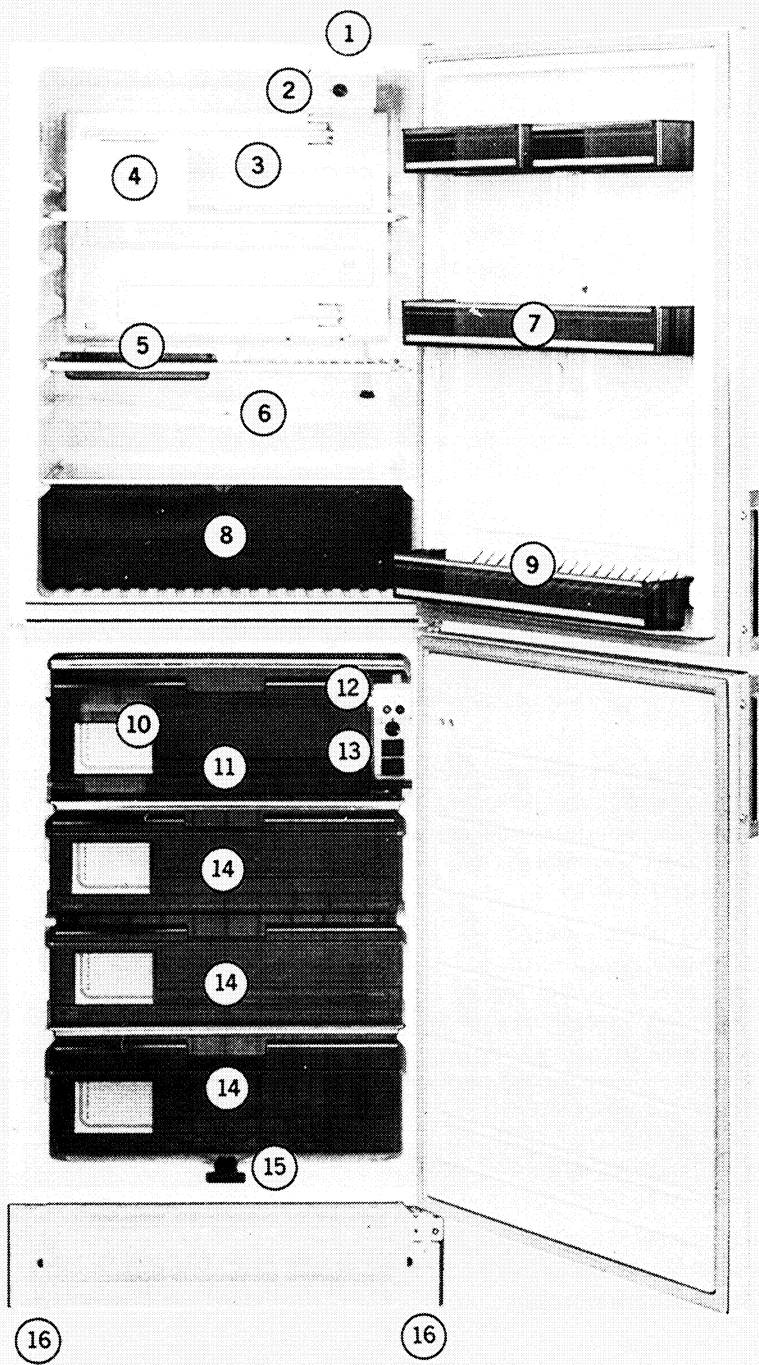

About your fridge/freezer

Door hang

The chosen position for your fridge/freezer may make it preferable to change over the hinges and door handles to reverse the door hang. To do this, refer to 'Changing over the door hinges' on page 16.

Decor panels

If preferred, you can fit decor panels to the doors to harmonise with other furnishings in your kitchen. Instructions for doing this are given on page 17.

Where to install

For the cooling unit to work efficiently, your fridge/freezer should be located in a dry atmosphere, out of direct sunlight and away from extreme temperatures, e.g. not next to a cooker or other sources of direct heat, or in a very cold room such as an outhouse, where the temperature may fall below 5°C (41°F).

Leave a clearance of at least 75mm (3ins) above the cabinet and don't obstruct the space underneath. The back may be placed close to the wall but should not touch it. Do not install in a small pantry or in other places with restricted ventilation.

Your fridge/freezer will be heavy when loaded with food and must therefore be stood on a strong firm floor. It should also be level. Adjustable feet are provided at all four corners of the cabinet and the front ones are accessible after removing the ventilator at the bottom front by turning the catch at each end with a small coin. Adjust the level by turning the square at the top of the appropriate adjuster thread with the spanner supplied — see illustration.

Make sure the appliance is upright and all feet are in firm contact with the floor so that the cabinet does not rock in any direction.

Connecting to the mains

Check that the voltage shown on the data plate conforms with your mains supply.

WARNING —

THIS APPLIANCE MUST BE EARTHED.

IMPORTANT

The wires in the mains lead of this appliance are coloured in accordance with the following code:-

GREEN-and-YELLOW : EARTH
BLUE : NEUTRAL
BROWN : LIVE

If a 3 pin 13 amp fused plug is used, it should be fitted with a 13 amp fuse; with other plug types, the circuit should contain a 10 amp fuse.

As the colours of the wires in the mains lead may not correspond with the coloured markings identifying the terminals in your plug, proceed as follows:-

Connect the GREEN-and-YELLOW coloured wire to the plug terminal marked letter E or earth symbol  or coloured green or green-and-yellow.

Connect the BLUE coloured wire to the plug terminal marked letter N or coloured black.

Connect the BROWN coloured wire to the plug terminal marked letter L or coloured red.

If at any time a replacement mains lead is required, the cross sectional area of its conductors must not be less than 0.75mm².

* However, we recommend that this operation be carried out by a member of the Electrolux Service Organisation or a qualified electrician.

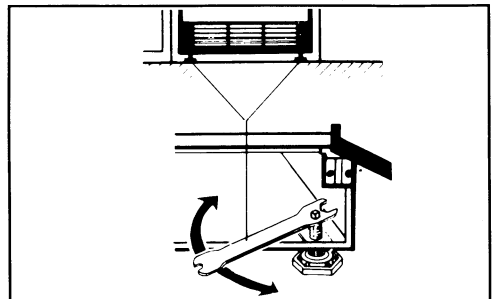

Setting the controls

The temperature in the fridge and freezer compartments will be affected by location, room temperature and frequency of door opening and adjustment of the thermostat setting may be needed to allow for this.

After starting up, we advise you to run your fridge/freezer for a day before storing frozen food.

This model has two separate thermostats, one in the fridge and one in the freezer, – see illustrations below.

The thermostat in the freezer switches the motor compressor on and off, controlling the temperature in the freezer, while the one on the refrigerator opens and closes a valve in the cooling system, allowing refrigerant to flow to the fridge cooling plate.

In addition to the thermostat in the freezer control unit, there are two warning lights, a fast freeze switch, and a mains on/off switch.

To start your fridge/freezer, plug into the wall socket, switch the socket on, and set the mains on/off switch to 'I' (ON); turn *both* thermostat knobs to setting No.4. (For normal use, the fast freeze switch should be off, i.e. set against 'N'.)

If colder temperatures are required in the fridge or freezer turn the thermostat knob(s) to a higher number. Note: If the freezer is set to run at a colder temperature, it may be necessary to set the refrigerator thermostat knob to a *lower* (less cold) setting to prevent the fridge compartment becoming too cold.

To switch off the fridge, turn the fridge thermostat knob to '●'. To switch off the freezer and fridge, set the mains on/off switch in the freezer to 'O' (OFF).

Note: The fridge can be switched off leaving the freezer running, but the freezer cannot be switched off leaving the refrigerator running.

Green temperature warning light

A few hours after starting up, this will come on to show that the correct temperature has been reached for the thermostat setting chosen and will

stay on to indicate that everything is in order.

The light will go out if the power fails or a fuse blows. It will also go out if the freezer temperature rises unduly, for instance, after opening the freezer door or placing food in the cabinet, but the light should come on again when the temperature returns to normal. If the green light goes out for an unknown reason it indicates that something may be wrong and should be investigated without delay.

Orange (fast freeze) indicator light

When the fast freeze switch is set to 'S' (SUPER), the orange indicator light will come on to remind you that it is in use.

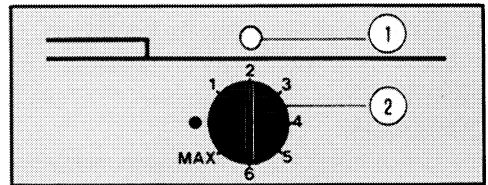

Fridge Control Unit

1. Interior light switch. 2. Thermostat knob.

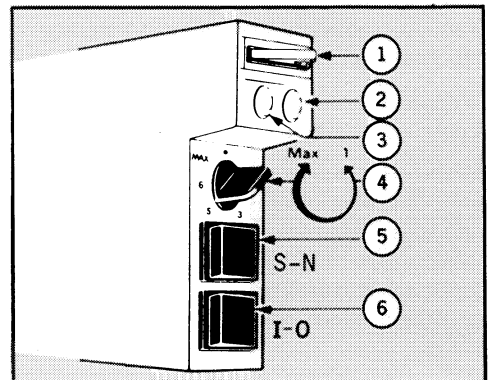

Freezer Control Unit

1. Interior light switch.
2. Green temperature warning light.
3. Orange fast freeze light. 4. Thermostat knob.
5. Fast freeze switch. 6. Mains on/off switch.
S = SUPER. N = NORMAL. I = on. O = off.

Using the fridge compartment

The fridge compartment provides suitable storage conditions for most kinds of fresh food, salads, milk, etc. Meat can be placed in the "wet tray" or the tray can be taken out to allow the storage of tall items, or extra bottles when there is no room in the door.

Alternative positions are provided for some of the cabinet shelves and door shelves to enable you to arrange the interior to suit your requirements.

The usable capacity of the fridge compartment is as follows:

TR1168D — 183 litres (6.4 cubic feet)

Suggested fresh food storage times

Storage times will vary according to the type of food and how fresh it is when put into the fridge but no food should be stored for longer than the times stated opposite.

Drink cooler

The drink cooler has a capacity of approximately 3 litres.

Fill the container with your favourite fruit drink, diluted squash, etc. and position it towards the front of an upper cabinet shelf with its spout protruding through the bars.

To dispense a drink, simply hold a glass under the spout and push in the button.

IMPORTANT. Clean your drink cooler regularly to prevent a build-up of sugary deposits. If deposits do form, soak in warm water until they dissolve then pour fresh water into the container and operate the dispenser button a few times to ensure it is free. The top of the container unclips for cleaning inside.

Suggested maximum storage times

Type of food	Storage time
Uncooked fresh meat	
poultry,	
beef and lamb	3–5 days.
pork	2–4 days.
sausages	3 days.
mince & offal	1–2 days.
Cooked meat	
ham, sliced meat	2–3 days.
pies	1 day.
casseroles & paté	2 days.
poultry	2–3 days.
Bacon	
	1 week.
Dairy produce	
milk	2–3 days.
cream	1 week.
butter	3–4 weeks.
hard cheese	3–4 weeks.
soft cheese	1 week.
Vegetables & Salads	
	1 week.
Fruit	
	2 weeks.

Using the freezer compartment

The ******* symbol means that your freezer will store food at -18°C (0°F) for long term storage and will also freeze fresh food.

Storing frozen food

Your freezer has the following capacity:

Model	Nett Storage Volume		*Weight of Stored Food	
	litres	cubic ft	kg	lb
TR1168D	140	4.9	44.8	98.5

**This is a standard measurement, the actual capacity depending on the density and sizes of the particular food stored. The above figures are based on an average density of 0.32 kg per litre.*

Pre-packed commercially frozen food should be stored in accordance with the manufacturer's instructions for 3 star frozen food compartments and should be put into the freezer as soon as possible after purchase. Your freezer provides for long term storage which generally means up to 3 months but the length of storage time can vary and it is important to follow the recommended times shown on packets of commercially frozen food.

Storage times for home prepared fresh frozen foods are given on pages 10, 11 and 12.

If your fridge/freezer breaks down or the power fails, don't open the freezer door and the frozen food won't be affected for up to 24 hours.

Any frozen food which thaws accidentally should be eaten as soon as possible or thrown away.

Alternatively, if the food is uncooked and it has not completely defrosted it can be cooked then refrozen. (Note that some items must be thawed completely before cooking – see page 13).

Cooked food that has defrosted must never be refrozen.

Freezing fresh food

In any 24 hours you can freeze up to the maximum quantity of fresh food shown in the table below. *Do not exceed the stated weight for the model concerned otherwise the freezing time will be prolonged and the refrigerator temperature may become too cold.*

Model	Max. weight of fresh food frozen in 24 hours	
	kg	lb
TR1168D	13	28.6

When the food is ready for freezing (see pages 8 and 9), place the packages in the freezer as given below. Existing frozen foods should be re-arranged in the freezer to leave space on the top shelf for freezing. The packets to be frozen should be placed on the top shelf in contact with the shelf surface as far as possible and spaced apart to allow cold air to circulate between them. They should not touch existing packets.

Set the fast freeze switch to 'S' (SUPER) 24 hours *before* loading the prepared and packaged fresh food in the freezer, placing it on the top shelf as given above. 24 hours *after* loading the food, return the fast freeze switch to 'N' (NORMAL).

No harm will result if you forget to turn off the fast freeze switch after 24 hours but, for reasons of economy, try to remember to turn it off when freezing is complete — the orange light should remind you of this.

Note: If while freezing food in the *refrigerator* temperature tends to become too cold, temporarily turn *its thermostat knob* to a lower numbered setting.

If there is room, when the food has frozen, you may transfer it to other parts of the freezer to allow you to freeze a further load of fresh food on the top shelf.

Practical Hints

Different foods need different methods of preparation and some will keep longer than others.

Of course, you can freeze practically anything, but don't waste space in your cabinet by storing foods which are readily available throughout the year.

Fruit is ideal — especially the softer varieties. But avoid pears because they lose their texture and discolour, and bananas, which will turn black.

Vegetables and herbs too are ideal, but salad vegetables and marrows are unsuitable because they contain too much water. Celery loses its crispness, so should be cooked first, and tomatoes are best frozen as purée. Onions should be chopped fine and frozen in small quantities.

All poultry, meat and fresh fish freeze well, as do baked goods, though for shorter periods.

As for prepared foods, these too can be frozen with confidence, but there are a few points to bear in mind.

Semi-liquid foods have a tendency to thicken, so should be made up a little slacker than normal. Highly spiced and aromatic dishes should be wrapped really thoroughly, so the flavour doesn't spread to your other frozen foods. Always cool them quickly and then freeze immediately.

General Preparation

For freezing purposes always choose the finest quality fresh foods.

Fruit & Vegetables

Fruit and vegetables should preferably be frozen immediately after harvesting or at least kept in a refrigerator for no longer than twenty-four hours. For perfect results fruit should be *just* ripe, and if any shows signs of being damaged it should be discarded. Most vegetables and some fruit need to be blanched before freezing to retard enzyme reaction. Timings for individual types are given in the detailed tables that appear later in this booklet.

Meat

Freeze joints in handy-sizes after removing waste such as bones, fat and so forth. Game must be hung for the desired period and cleaned *before* being frozen.

Fish

Should preferably be frozen within twenty-four hours of being caught. Any superfluous scale should be removed along with the fins, then the fish gutted and washed clean in cold salted water before being frozen.

Poultry

Gut, singe and wash birds thoroughly. Tie legs and wings to the body before placing in the freezer, or cut into joints for packing separately — giblets should be packed separately, where possible.

Dairy Products & Baked Items

See individual details in tables which appear later in this booklet.

Prepared Foods

These freeze well, but remember that seasonings will become intensified during frozen storage, so be very sparing and add whatever you like when ready for eating. Salt actually shortens the storage time for all types of frozen foods, so add only a little during preparation.

Freezing fresh food (cont'd)

Blanching

Where necessary, (see remarks column on page 11), plunge vegetables into boiling water for the specified period, timing from the moment of return to boil. Then drain and cool immediately in iced water before packaging and freezing.

Packaging

Proper packing is one of the most important points about food freezing, if the true quality is to be preserved.

All food should be carefully wrapped in airtight moistureproof materials. It should be completely covered and as much air as possible shut out to prevent 'freezer-burn' — those blemishes which appear on thawing.

The majority of materials you are likely to require will be readily obtainable from your own home freezer supplier, the larger stationery shops and department stores. Most useful are heavy gauge polythene bags or sheeting and plastic containers with tight-fitting lids — also the thicker kinds of aluminium foil.

As far as possible try to pack food in even shapes and sizes to maximise the space available in your freezer cabinet and facilitate removal when required at a later date.

Labelling

The self-adhesive type of label is probably the most useful as it can be used on every kind of surface. Each label should show clearly what kind of food is in the package, its approximate weight or likely number of servings, the date of initial storage and any comments relevant to ultimate use.

In addition, keep a notebook handy to enable you to rotate your stocks and check your family's requirements on a daily basis for future reference, so you can plan your household budget accordingly.

The ice store

Ice making

The freezer compartment includes an ice store enabling you to build up a supply of ice cubes for a forthcoming party or spell of hot weather when ice will be in demand. The ice tray fits in the top of the ice store.

First, make ice cubes by filling the ice tray with fresh drinking water to the top of each ice cube compartment and placing the tray in the top of the ice store, or, for quickest ice making, directly on the freezing shelf.

When the ice cubes have formed, hold the tray upside down over the ice store and twist the tray along its length, allowing the loosened cubes to fall into the store.

Several makings of ice cubes can be accommodated and, of course, you can also leave the ice tray full of cubes, conveniently placed on top of the ice store.



Freezing Foodstuffs — Individual Characteristics

	<i>Max. Storage Period</i>	<i>Method</i>	<i>Remarks</i>
MEAT joints			
Beef	10–12 months	Cut to handy size. Wrap thoroughly	
Pork	6–9 months	Cut to handy size. Wrap thoroughly	
Lamb	9–12 months	Cut to handy size. Wrap thoroughly	
Offcut Steak	10–12 months	Separate with cellophane layers	
Chops	see Pork or Lamb above	Separate with cellophane layers	Wrap carefully to protect against puncturing by sharp bones
Veal Fillets	6–9 months	Separate with cellophane layers	
Bacon, cured smoked	6 weeks 1 month	Separate with cellophane layers	Pack in handy meal portions
Sausages	6 weeks	Wrap tightly	Pack in handy meal portions
Minced meat	2 months	Wrap tightly	Pack in handy meal portions
Offal and tripe	3 months	Clean thoroughly. Pack in small portions	Make sure it is really fresh
POULTRY			
Chicken	9–12 months	Clean in usual way, joint if necessary	Wrap giblets separately — do not stuff till ready
Turkey	9–12 months	Clean in usual way, joint if necessary	
Duck, Goose	6 months	Clean in usual way, joint if necessary	
Giblets	3 months		Wrap separately from bird
GAME			
All types	6 months	Hang before freezing, prepare as for poultry	Cook immediately after thawing
FISH			
All types	3–6 months	Clean, discard head and tail, wrap separately	Must be fresh
Trout	4 months	Clean, discard head and tail, wrap separately	Must be fresh
Salmon	4 months	Clean, stuff with greaseproof paper for shape retention, or cut into steaks	Must be fresh
VEGETABLES			
Mushrooms	12 months	Wash, dry thoroughly. Freeze loose (or sauted in a little butter till partially cooked, then freeze)	Pack viable quantities in boxes

	<i>Max. Storage Period</i>	<i>Method</i>	<i>Remarks</i>
Potatoes	10 – 12 months	New potatoes and chips can be frozen raw. Otherwise cook partially in one of usual forms, cool then freeze	
Beans	12 months	Peel or pod, and wash	Blanch for 2 mins., cool for same time in iced water then freeze
Carrots	12 months	Use small ones. Prepare	Blanch for 5 mins.
Cauliflower	12 months	Break up into florets	Blanch for 3 mins.
Spinach	12 months	Wash thoroughly. Remove thicker veins	Blanch a few leaves at a time, for 2 mins.
Sprouts	12 months	Use only small ones. Remove outer leaves	Blanch for 3 mins.
Root crops	12 months	The younger the better. Peel and slice or freeze whole	Blanch for 3 mins.
FRUIT			
Apples	9 – 12 months	Freeze either of two ways: As purée-stew with little water, beat to smooth pulp, sweeten to taste, cool. OR Sliced-blanch for two minutes, drain and cool. Pack tightly in layers with a little dry sugar sprinkled between, if so desired; or soak in slightly salted water for ten minutes, dry and freeze	Freeze in small quantities. Pack in plastic containers, leaving ½" headroom ditto
Apricots	10 – 12 months	Preferably remove stones, but leave skins on. Pack in syrup ½ – 1 lb. sugar to 1 pint of water, making sure fruit is covered	Pack in plastic containers, leaving ½" – 1" headroom
Cherries	12 months	ditto	ditto
Damsons	12 months	ditto	ditto
Plums	9 months	ditto	ditto
Gooseberries	12 months	ditto	ditto
Blackberries	12 months	Either pack in syrup as above, or coat with caster sugar and pack in plastic containers. Also may be frozen loose: spread on trays allowed to freeze overnight and then packed in containers	ditto
Currants	12 months	ditto	ditto
Raspberries	12 months	ditto	ditto
Strawberries	12 months	ditto	ditto

	<i>Max. Storage Period</i>	<i>Method</i>	<i>Remarks</i>
Peaches	10 months	Cover with boiling water for 1 minute, then cool by dipping into cold and peel carefully. Cut into halves, removing stone. Use syrup method of packing and freezing	Keep fruit submerged in syrup; place crumpled greaseproof paper on top, so there is no room between the surface of the liquid and the lid

DAIRY PRODUCTS

Egg Whites	10 months	Eggs must always be separated. Place whites in small containers just a few at a time	Eggs frozen in their shells will crack
Egg Yolks	10 months	As for whites, but to prevent coagulation mix with ½ tsp. salt or 1 tsp. caster sugar to every two yolks	Use for savoury or sweet dishes accordingly
Butter	6 months (unsalted) 3 months (salted)	Wrap bought butter in foil and freeze	
Cream Whipping and Double only	4 months	Must first be beaten lightly before freezing	Allow slight room for expansion in the container
Cheese	8 months (soft) 3 months (hard)	Wrap all varieties tightly in foil	Hard cheese stores much better when grated

BAKED ITEMS Wrap in foil or polythene bags

Bread (Freshly baked)	1 – 2 months		
Cakes, plain	6 months	Just wrap and freeze	
Cakes, iced	3 months	Freeze without wrapping, then wrap and store in polythene	

PREPARED FOODS

Stews	2 months	May be frozen quite satisfactorily in a polythene bag	
Sauces	4 months	Freeze in quantities of ½ pint. A little extra liquid may be required, when you come to use it	Egg based sauces are unsuitable
Full courses	3 months	Assemble individual helpings on specially constructed aluminium trays, then cover with foil. To re-heat leave the cover on and put in the oven for about 45 minutes at 400°F (200°C)	Cover slices of meat with gravy to prevent drying out

Thawing food

Thawing Food

Fruit

Keep container closed and allow to thaw at room temperature for about five hours.

Vegetables

No thawing needed — place in salted boiling water, cover and time cooking from moment of return to boil. It only takes a few minutes. Can also be put in the oven with a knob of butter. Chips and courgettes can go into hot fat.

Meat, Poultry etc.

Small jointed items don't require thawing before cooking, but always choose a moderate temperature and allow for a longer cooking time than normal so the meat cooks right through.

However, large items, such as a whole chicken must be thawed first; allow two to three hours per pound at room temperature, then proceed as usual.

Dairy Products

Allow eggs to thaw in closed containers and use immediately. Butter and cream will thaw in one to two hours at room temperature.

Baked Items

Bread takes about two hours to thaw or loaves may be heated in the oven. Cakes can be sliced in their frozen state to retain shape and speed the thawing process.

Prepared Foods

Heat gently in closed containers in the oven.

Commercial Packs

Simply follow the printed instructions.

Important points to remember

DO . . .

adjust the level of your fridge/freezer before loading it with food, — see page 4.

cover or wrap liquids and foods, particularly those with strong odours.

put vegetables and salads in the salad drawers, in plastic bags.

cover melons and pineapples and only store for short periods.

rotate stocks of frozen foods; date markings will help with this.

keep the refrigerator drain outlet clear; if blocked carefully clean it with a piece of flexible curtain wire.

leave the doors ajar when the fridge/freezer is not in use.

DON'T . . .

obstruct air circulation in the fridge by tightly packing stored items.

put hot food in the fridge or freezer.

let food or containers touch the refrigerator cooling plate.

store bananas in the fridge or freezer or they will turn black.

put bottles or cans of fizzy drinks in the freezer.

give children iced lollies straight from the freezer, they could cause frost burns.

use a sharp instrument to hasten defrosting or to remove an ice tray.

leave the drink cooler with residues in it which might harden or go stale. Always rinse out and dry the container as soon as it becomes empty.

Looking after your fridge/freezer

How to defrost

The *Fridge Compartment* is defrosted *automatically*. Defrost water from the cooling plate runs out of the drain and onto a tray on the motor compressor where it is evaporated. This process is completely automatic. Droplets of water on the cooling plate during defrosting are quite normal and will freeze on the plate afterwards.

In the *Freezing Compartment* frost accumulates on the cooling surfaces during normal working and should occasionally be removed using a stiff bristle brush or a plastic scraper.

Heavy frosting (about 1/4" thick) will reduce the freezer's efficiency and therefore complete defrosting should then be carried out, probably at 6 month intervals, depending on usage. Preferably you should do this when there is little or no food in the freezer, in the following manner:

1. Any remaining frozen food should be placed in another freezer, or in cardboard boxes and wrapped in blankets, layers of paper, or other suitable insulating material. Put in a cool place.
2. Switch off at the wall socket and remove the plug.
3. Fold out the defrost flip spout, put a suitable container under it to collect the defrost water, and leave the door open.

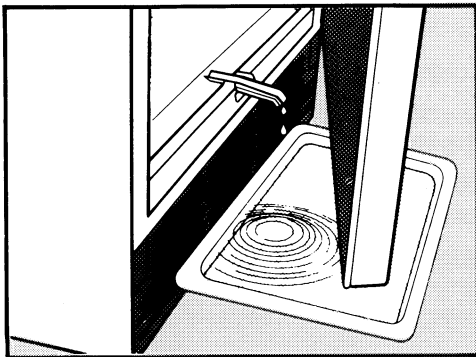

4. Defrosting can be speeded up by putting bowls of hot (not boiling) water on the shelves of the freezer and loosening the frost with a stiff bristle brush or a plastic scraper.

5. After defrosting, clean and dry the interior as explained under "Cleaning" and fold back the defrost flip spout.

6. Replace the plug and switch on. Check that the controls are at the required setting, replace frozen food, and close the door.

REMEMBER, if the temperature of frozen food is allowed to rise unduly during defrosting, its storage life may be shortened.

Cleaning

The most suitable time to clean your fridge/freezer is after defrosting the freezer. Remember to first switch off and pull out the plug from the wall socket.

Both compartments and all the fittings should be thoroughly cleaned with a clean cloth wrung out in a solution of one teaspoonful of bicarbonate of soda in each pint of water.

For safety reasons, the larger freezer baskets are fitted with stops but they can be removed by pulling them forward then lifting the front and pulling all the way out. Re-fit by reversing this procedure.

The outside should be occasionally dusted or wiped over with a damp cloth and a small amount of detergent. But not the door seals, which should be cleaned only with soap and water and thoroughly dried.

Never use detergents, abrasive powders, highly perfumed cleaning materials or wax polishes to clean the interior as these will damage the surfaces or leave a strong smell.

A small amount of wax polish applied every few months will maintain the gloss finish of the outside.

The motor compressor and condenser at the rear

should also be cleaned of dust occasionally using a brush, but make sure the freezer is unplugged when you do this.

Occasionally, strong smelling food may leave the fridge with a slight odour. Placing a small dish of bicarbonate of soda powder in the fridge should slowly absorb these smells. The dish should be refilled periodically.

Going on holiday

Don't switch off at the mains if you intend to leave food in the refrigerator and/or freezer.

For 2 days or less there is no need to remove any food from the refrigerator. For up to a week, remove all food except eggs, butter and bacon.

On this model you can turn off the refrigerator by turning its thermostat knob to '●', leaving the freezer operating on its own. *In this case, remember to empty, clean, and dry the fridge compartment and leave the refrigerator door open to prevent odours accumulating inside.*

If you are leaving both the refrigerator and freezer compartments empty, switch off at the wall socket and remove the plug. Defrost, clean and dry, **and leave both doors open.**

Changing a bulb

Should the interior light fail to illuminate, *first switch off and pull out the mains plug*, then fit a new bulb as given below. (The replacement must be of the correct type and wattage and is available from your nearest Electrolux Service Shop as listed on page 18).

Interior light bulb — refrigerator.

Pull the light cover downwards to disengage it from the housing at the top. Unscrew the bulb and replace it with a new one of similar type and wattage. Re-fit the cover by pushing it back into place, the projections at the top engaging the slots in the housing.

Interior light bulb — freezer.

Remove the light cover by pulling out the bottom of the cover, towards the centre of the cabinet, until it unclips. Unscrew the bulb and fit a new one of similar type and wattage. Re-fit the cover, engaging the top over the housing before pushing the bottom into place.

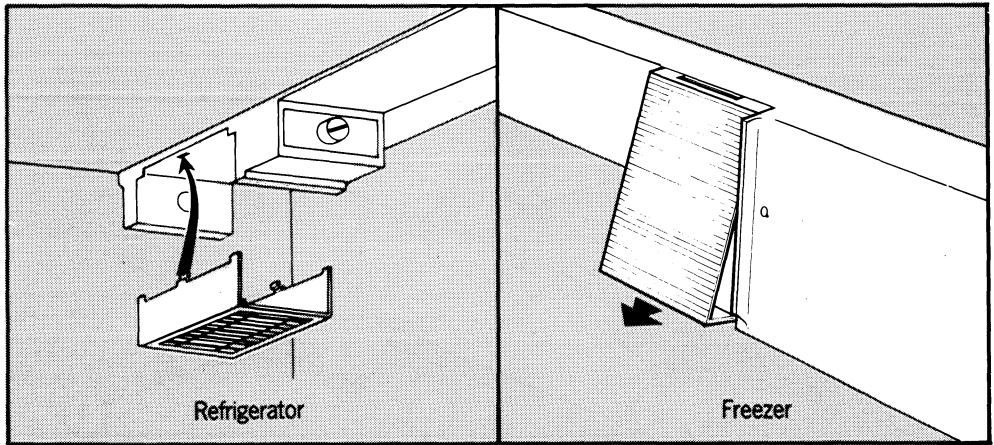

Changing over the door hinges

1. If your fridge/freezer is already in use, disconnect it from the electricity supply and take out food etc. Temporarily store frozen food in cardboard boxes wrapped in blankets or other suitable insulating material.

2. Take out all loose items then gently lay the appliance on its back. Remove the ventilator at the bottom front by turning the slotted catch at each end.

3. Remove the lower hinge (9) from the cabinet, held by three screws (7). Using the spanner supplied remove the hinge pin (8) from the hinge and fit it to the opposite corner of the hinge.

4. Remove the lower door, lifting it at the bottom before disengaging it from the centre hinge pin (1).

5. Take off the upper hinge (3), held by two screws, then remove the upper door, lifting it at the top before disengaging it from the centre hinge pin (1).

6. Remove the centre hinge pin (1) from the cabinet cross-member (2) by loosening the locknut (5) with the spanner and unscrewing the spacer (4). Fit the hinge pin to the hole at the opposite end of the cross-member, ensuring that the spacer (4) is at the top and its lower end fully enters the hole in the cross-member.

7. Re-fit both doors, engaging them with the centre hinge pin before lowering the opposite ends into position.

8. Transfer the plastic blanking piece on the top of the cabinet to the opposite side but don't overtighten the screw. Re-fit the upper and lower hinges to the cabinet in their new positions, their hinge pins entering the bushes in the doors.

9. Transfer the handles to the opposite sides of the doors using the "Allen key" supplied on screws having a hexagonal recess.

10. Stand the appliance upright and check that the centre hinge pin assembly is as illustrated, i.e. with the bottom part of the spacer (4) fully in the hole in the cross-member and the hexagon (6) of the hinge pin just clear of the bush in the top of the lower door. If necessary, adjust by turning the hexagon (6) of the hinge pin with the spanner. When correct, lightly tighten the locknut (5) against the bottom of the cross-member.

11. Transfer the clip-on blanking piece from one end of the ventilator to the other then fit the ventilator to the cabinet.

12. Place the fridge/freezer in the installed position, adjust the level (see page 4), then check that the doors open and close correctly.

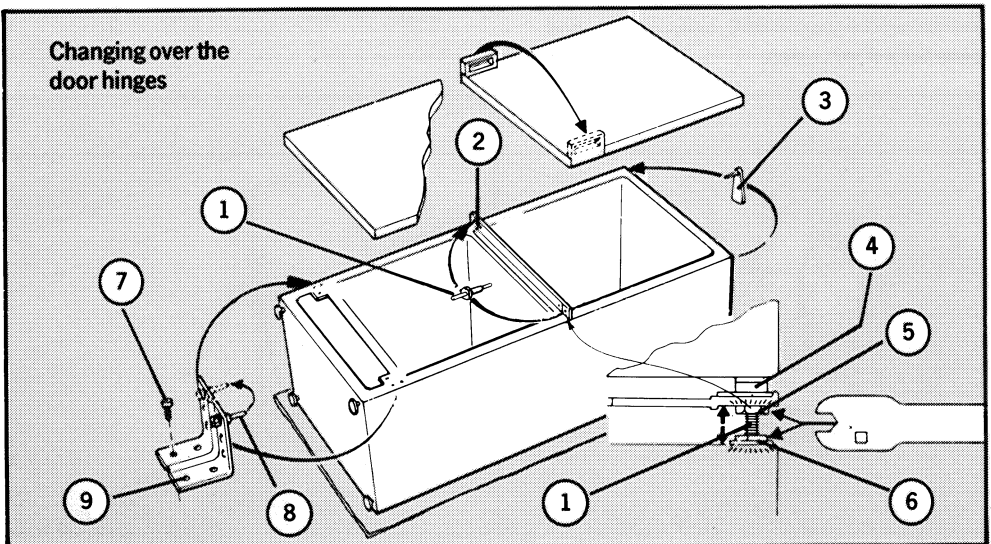

Something not working

Fitting decor panels

The doors of the fridge/freezer will accept your own decor panels if you wish to fit them to match other equipment in your kitchen. The panels should be 1 to 2 mm less in height and width than the doors and should not exceed 4 mm in thickness

To fit decor panels.

1. Carefully pull off the emblems and nameplate which are stuck to the front of the doors, taking care, not to disturb the lenses of the warning lights on the freezer door.
2. Remove the screws and take off the handles and decor panel retaining strips from the handle sides of the doors. Take out the screws from the top decor panel retaining strips and loosen the screws holding the other strips (The "Allen key" supplied is for screws having a hexagonal recess in the head.)
3. Carefully mark on the freezer door decor panel the positions where the warning light lenses will be and cut an opening in the panel just large enough to clear the two lenses.
4. Slide the decor panels under the edges of the retaining strips still on the door and re-fit the strips, handles, and screws previously removed. Tighten all screws, pushing the strips against the decor panels while doing this to ensure a snug fit.

Before you call for a Service Engineer, carry out these simple checks:

Is there a power failure? Check your house lights. If so, keep the freezer door closed until the power is restored.

Is the plug firmly connected to the wall socket and is the socket switched on? Check the power supply by plugging in another appliance or a table lamp.

Is the fuse in the plug intact and are the wires in the mains lead correctly connected to the plug? (See "Connecting to the Mains", page 4).

Are the thermostat(s) and switches at the correct settings?

Have the doors been left open causing the temperature to rise?

Sometimes the freezer door will be difficult to open shortly after you have closed it. Don't worry; this is due to a pressure difference which will quickly equalise and allow the door to open normally.

If after checking these points, your fridge/freezer still won't work, call your nearest Electrolux Service Office without delay. It is listed opposite.

When calling, tell us your name, address with postcode, telephone number and what appears to be wrong. Also the Model number of your fridge/freezer and when and where you purchased it.

For future reference we suggest you record these details here, and keep the receipt with the handbook as proof of purchase.

Purchased from _____

Date Purchased _____

Model Number _____
(see data label inside freezer)

Electrolux Service Organisation



ELECTROLUX SERVICE OFFICES

Should any breakdown occur with your appliance simply telephone your nearest Service Office or Service Shop, explain the nature of your problem and quote your Model number.

REGIONAL SERVICE OFFICES

Scotland & North Eastern Region

Electrolux Service, Epic House, 28-32 Cadogan Street, Glasgow G2 7LR. 041-204 0411

Northern Region (Inc. N. Ireland)

Electrolux Ltd., Altham Lane, Altham, Accrington, Lancs., BB5 5XY. Padiham 74621 (STD Code 0282)

Midlands & South Wales Region

Electrolux Ltd., 3 Strensham Hill, Moseley, Birmingham B13 8AQ. 021-449 5252

London Region

Electrolux Ltd., 842 Coronation Road, Park Royal, London NW10 7QA. 01-965 9699

Southern Region

Electrolux Ltd., Hippodrome House, Birchett Rd., Aldershot, Hants. G11 1LU. Aldershot 24505 (STD Code 0252)

ELECTROLUX SERVICE SHOPS

Aberdeen 695761 (STD Code 0224)
 Ayr 262242 (STD Code 0292)
 Bedford 219000 (STD Code 0234)
 Belfast 740 296/7 (STD Code 0232)
 Brighton 694341 (STD Code 0273)
 Bristol 211876 (STD Code 0272)
 Cardiff 387444 (STD Code 0222)
 Carlisle 44568 (STD Code 0228)
 Cheltenham 584051 (STD Code 0242)
 Chester 312038 (STD Code 0244)
 Dundee 22630 (STD Code 0382)
 Edinburgh 031-229 1232
 Exeter & E. Devon 217138 (STD Code 0392)
 Gateshead 4600440 (STD Code 091)
 High Wycombe 41042 (STD Code 0494)
 Inverness 223056 (STD Code 0463)

Jersey (St. Saviour) Central 22138 (STD Code 0534)
 Leeds 608511 (STD Code 0532)
 Liverpool 051-220 8014
 Luton 575966 (STD Code 0582)
 Maidstone 677727 (STD Code 0622)
 Manchester 061-798 9689
 Northampton 69222 (STD Code 0604)
 Norwich 667017 (STD Code 0603)
 Nottingham 396927 (STD Code 0602)
 Plymouth 58161 (STD Code 0752)
 Sheffield 338674 (STD Code 0742)
 Southampton 785231 (STD Code 0703)
 Southend 354313 (STD Code 0702)
 Stockton-on-Tees 674848 (STD Code 0642)
 Stoke-on-Trent 413414 (STD Code 0782)
 Swansea 51848 (STD Code 0792)

Guarantee

This Guarantee is offered to you as an extra benefit and does not affect your legal rights.

Electrolux products are carefully designed, manufactured, tested and inspected and in consequence we undertake to replace or repair any part found to be defective in material or workmanship, within one year of delivery to the original purchaser, free of charge.

ADDITIONALLY, DURING THE SUBSEQUENT FOUR YEARS, ANY DEFECTIVE PARTS WILL BE REPLACED FREE — LABOUR COSTS ONLY BEING CHARGEABLE, provided that within 14 days of the purchase the Guarantee Registration Card is completed and returned to the Company.

The Company does not accept liability for defects arising from neglect, misuse, or accident. Interior light bulbs and glassware are also excluded from the guarantee and the drink cooler is covered for the first year only.

There are certain conditions which may invalidate this guarantee:

- a) It is dependent upon the appliance being correctly installed and used in accordance with the Company's instructions under normal domestic conditions within the United Kingdom or the Republic of Ireland.
- b) Service under the guarantee must be carried out by an Electrolux service representative or authorised agent.
- c) The guarantee may be invalidated by unauthorised repair or modification of the appliance.

Proof of the date of purchase will be required before service under guarantee is provided. Addresses or telephone numbers for service requests are listed on page 18.

We must point out that this guarantee does not cover liability for loss of food or other contents, but would draw your attention to the insurance facilities described on the separate leaflet.

REFRIGERATOR/FREEZER TR1168D — A LUX MODEL, MADE IN SWEDEN

These appliances conform with the requirements of
EEC Directive No. 82/499 relating to radio interference.

 **Electrolux**®

ELECTROLUX LTD., LUTON, BEDS. LU4 9QQ

In accordance with its policy of progressive product design
the Company reserves the right to alter specifications.

T619

©Electrolux Ltd., 9/87

Publication N°.

8220049